



D5H/100S - Lincat Seal 500 Series Counter-top Heated Merchandiser - Self-Service - W 1000 mm - 2.02 kW

Keep hot meats, pasties, pies and other foods at the perfect temperature with the Seal 500 Range Heated Merchandiser.

- ✓ Elegant extruded aluminium frames and metallic silver finish enhance display without detracting from contents
- ✓ Precise thermostatic control up to 95°C with digital display of cabinet temperature ensures food is maintained at a safe temperature
- ✓ Minimum food holding temperature of 72°C
- ✓ Humidity feature prevents food drying out - food stays in optimum condition for longer, reducing waste
- ✓ All-round visibility to maximise food sales potential
- ✓ Daylight-balanced illumination to enhance display of contents with easy change clip-in fluorescent light tubes

Specifications

Summary

Brand	Lincat
Range	Seal
Series	500 Series
Power Type	Electric
Unit Type	Counter-top
Available in UK Only	No
UK Warranty	2 Years Parts and Labour Warranty
Export Warranty	Contact your local dealer
GTIN	5056105104049

Power and Performance

Total Power kW	2.02
Temperature Range °C	72-95
IP Rating	IP33
Temperature Control	Mechanical

Key Specifications

Number of Shelves included	2
Number of Shelf Positions	2
Service Type	Self service
Rack Type	Static
Type of Lighting	Fluorescent
Heated Base	Yes

Weights and Dimensions

Unit Height (External) mm	575
Unit Width (External) mm	1000
Unit Depth (External) mm	500
Shelf Dimensions Width mm	900
Shelf Dimensions Depth mm	375
Net Weight Kg	47

Supply Connections

Requires Installation	No
UK 3 Pin Plug	Yes
Requires Hardwiring	No
Electrical Supply Rating Watts	2,020
Single Phase Amps	8.7
Single Phase Voltage	230

Shipping

Packed Weight Kg	61.5
Packed Height cm	68
Packed Width cm	115
Packed Depth cm	75

Technical Picture

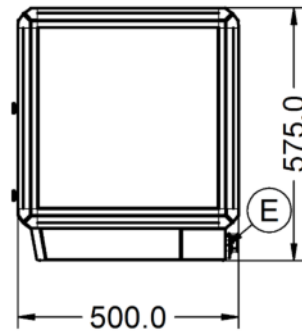
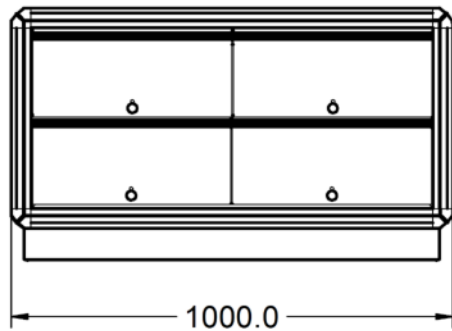

Lincat Limited

Whisby Road,
Lincoln, LN6 3QZ,
United Kingdom

Company No: 2175448

A member company of



Customer Care

Tel: +44 1522 875500
Email: care@lincat.co.uk

Export Customers

Tel: +44 1522 875536
Email: export@lincat.co.uk

Opening Hours

Monday – Friday:
8.30am – 5pm