



LDF - Lincat Lynx 400 Electric Counter-top Single Tank General Purpose Fryer - 1 Basket - W 270 mm - 3.0 kW

The 3kW Lynx 400 Electric Counter Top Fryer is designed to plug in and play, which means that you'll be producing perfect fried chips in no time at all.

- ✓ Removable control head to aid easy cleaning and maintenance
- ✓ Thermostatically controlled to give better and more consistent cooking results
- ✓ Safety thermostat to prevent overheat
- ✓ Stainless steel tanks for easy cleaning
- ✓ Comes with batter plate to allow open frying
- ✓ Nickel plated baskets for easy cleaning
- ✓ Plug and play for an easy installation

Specifications

Summary		Power and Performance	
Brand	Lincat	Total Power kW	3.0
Range	Lynx 400	Temperature Range °C	130-190
Power Type	Electric	IP Rating	IP23
Unit Type	Counter-top	Temperature Control	Mechanical
Available in UK Only	No		
UK Warranty	2 Years Parts and Labour Warranty		
Export Warranty	Contact your local dealer		
GTIN	5056105101024		

Key Specifications		Capacity	
Number of Baskets	1	Product Output per Hour	8kg chips - 12mm [frozen], 11kg chips - 12mm [chil]
Number of Tanks	1	Capacity Litres	4.0
Gravity Filtration	No		
Pumped Filtration	No		

Weights and Dimensions		Supply Connections	
Unit Height (External) mm	315	Requires Installation	No
Unit Width (External) mm	270	Requires Electrical Supply	Yes
Unit Depth (External) mm	417	UK 3 Pin Plug	Yes
Net Weight Kg	8	Requires Hardwiring	No
		Electrical Supply Rating Watts	3,000
		Single Phase Amps	13.0
		Single Phase Voltage	230

Shipping	
Packed Weight Kg	13
Packed Height cm	42
Packed Width cm	48
Packed Depth cm	38

Technical Picture

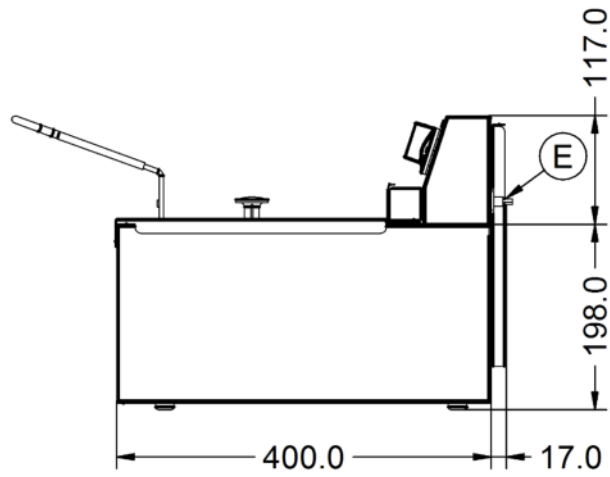
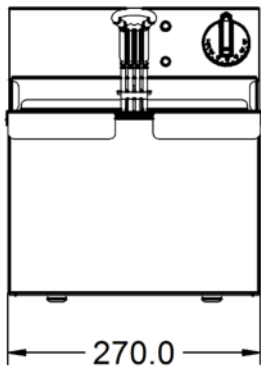
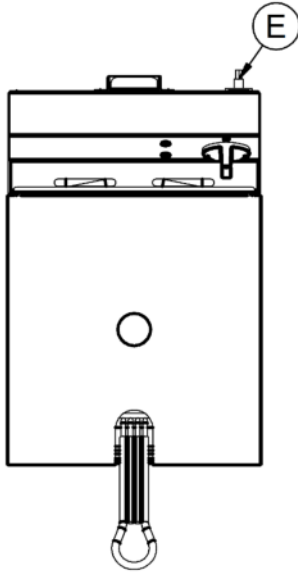

Lincat Limited

Whisby Road,
Lincoln, LN6 3QZ,
United Kingdom

Company No: 2175448

A member company of



Customer Care

Tel: +44 1522 875500
Email: care@lincat.co.uk

Export Customers

Tel: +44 1522 875536
Email: export@lincat.co.uk

Opening Hours

Monday – Friday:
8.30am – 5pm